

Data Sheet

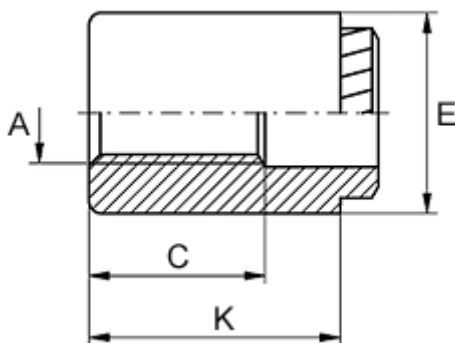

Article number: 12510600050100
Description: KLEE-coil 510 600 050.100
M5 Hardened, zinc-pl.

Measures



Female thread A	= M5
Height K	= 10
Hole diameter +0.1	= 6.8
Min distance to edge	= 4.1
Min material thickness	= 1.5
Outer diameter E	= 9
Thread length	= 9